

CLADMATE

CladdingSystems

CMS08

SIKA GLASS CLADDING SUPPORT
SYSTEM

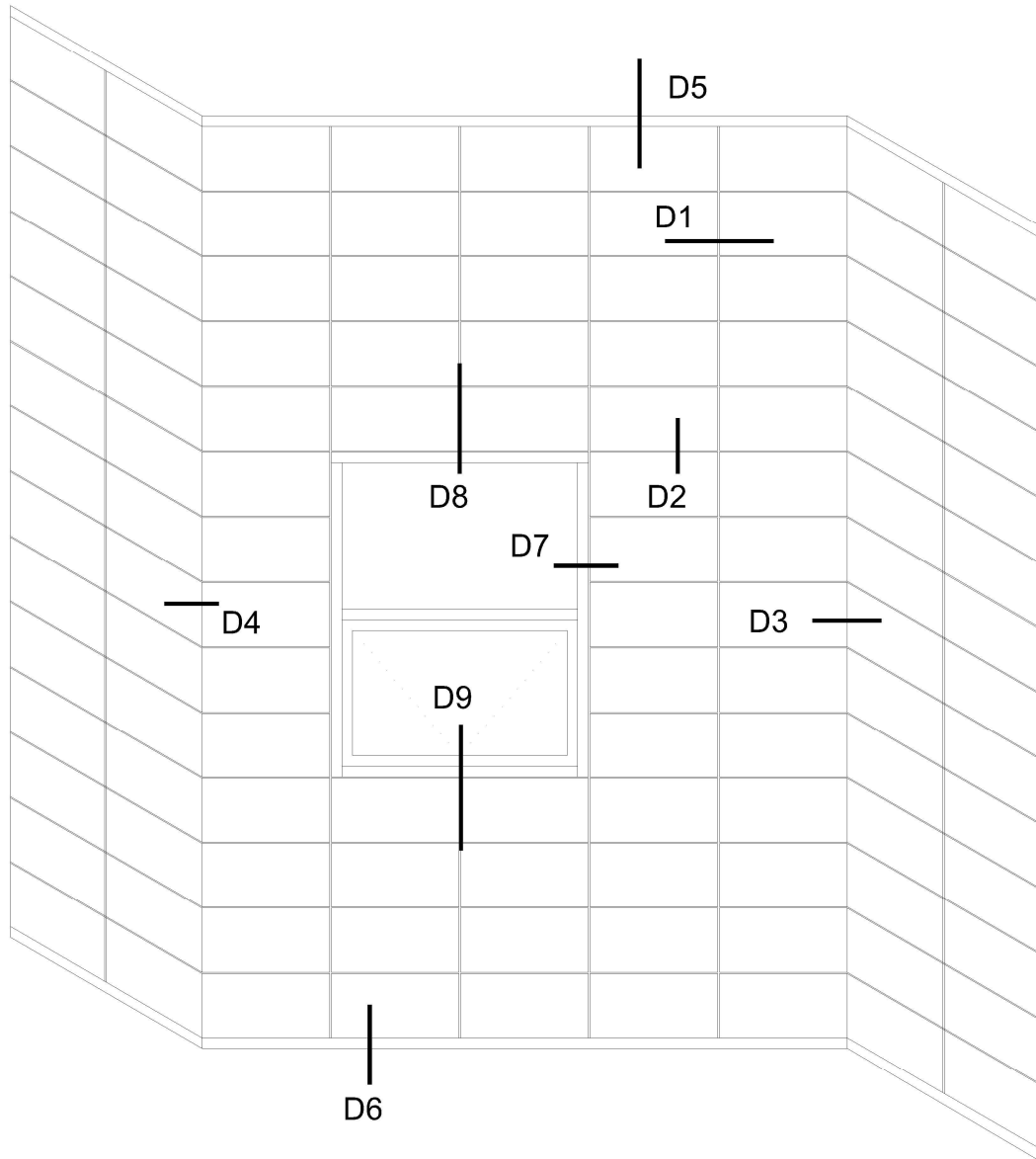

1. CONCRETE / BLOCK WORK
2. BREATHER MEMBRANE
3. THERMAL ISOLATOR
4. SUPPORT BRACKET
5. PRIMARY FIXING
6. THERMAL INSULATION
7. T / L / CORNER PROFILE
8. SELF DRILL SCREW
9. DOUBLE SIDED TAPE / NORTON TAPE
10. GLASS PANEL
11. RIVET/SCREW
12. VENTILATION
13. RAIL PROFILE
14. CLIP
15. BOX SECTION
16. MECHANICAL FIXING BRACKET
17. STRUCTURAL ADHESIVE

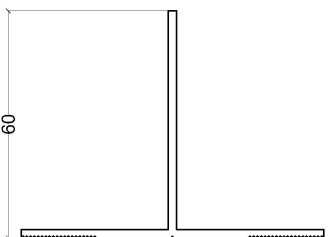
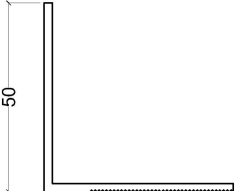
code	name	profile features	code	name	profile features
	T Profile			L Profile	
					
TP60 Series TP60-80-2.2-3000/6000 TP60-100-2.2-3000/6000 TP60-120-2.2-3000/6000 TP60-140-2.2-3000/6000		colour/finish : RAL & Anodised TBC	LP50 & LP60 Series LP50-50-2.2-3000/6000 LP60-40-2.2-3000/6000 LP60-40-2.5-3000/6000		colour/finish : RAL & Anodised TBC

Horizontal Rail Bottom Clip

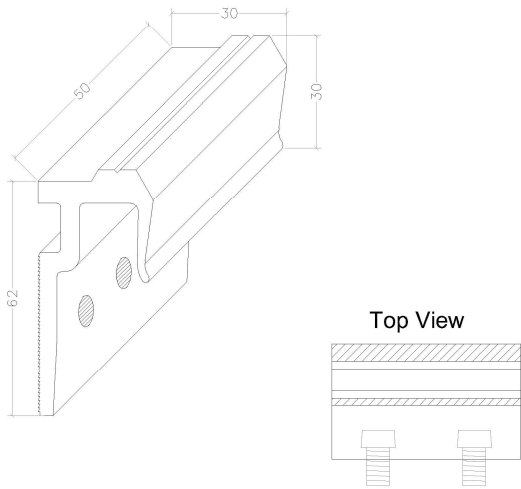

HRC-09-BC-50

colour/finish :
Anodised TBC

Horizontal Rail Top Clip

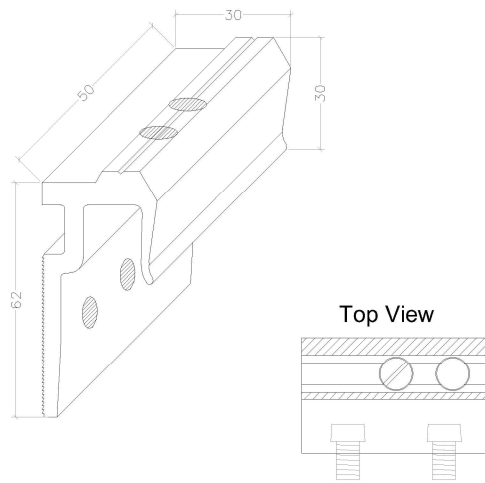

HRC-09-TC-50

colour/finish :
Anodised TBC

Box Section

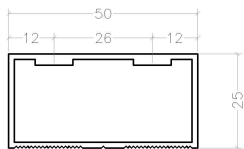

.....

colour/finish :
Anodised TBC

Top & Bottom Clip

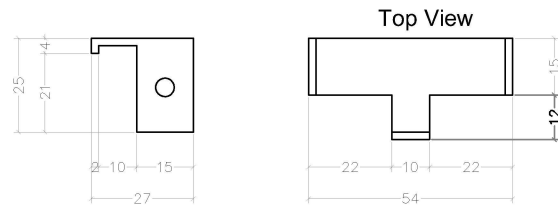

.....

colour/finish :
Anodised TBC
Visible end to be ceramic coated to match glass panel

Horizontal Support Rail

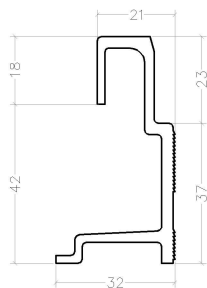

HRP-09-60-3000/6000

colour/finish :
Anodised TBC

Stainless Steel Rivet

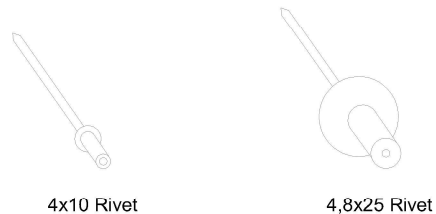









4x10 Rivet

4,8x25 Rivet

TP01

colour/finish :
RAL TBC

code	name	profile features	code	name	profile features
	Masonry Primary Fixing			Masonry Primary Anchor Bolt Fixing	
					
					
SDF-KB-10H-80E SDF-KB-10H-100E		colour/finish : Stainless Steel	BA-E-10/10 BA-V-10/10		colour/finish : Stainless Steel
	Self Drive Screw			Steel Frame Primary Fixing (Bi-met Fastener Washer)	
	3,9x19 YSB (M.U.V)				
	4,8x16 YSB (M.U.V)				
			JT3-3-6.3-38-S16 JT3-3-6.3-50-S16		
					
	Adj. Screw			Screw	
					
	M8x10 Bolt				
					
		colour/finish :			colour/finish :

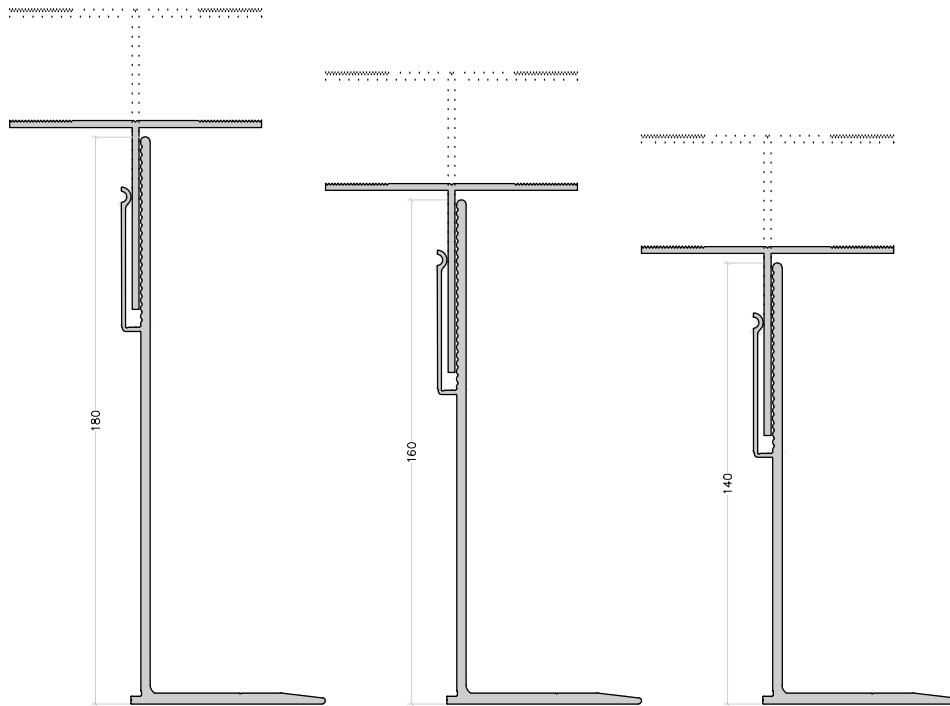

ADJUSTMENT
185 - 225mm

ADJUSTMENT
165 - 205mm

ADJUSTMENT
145 - 185mm

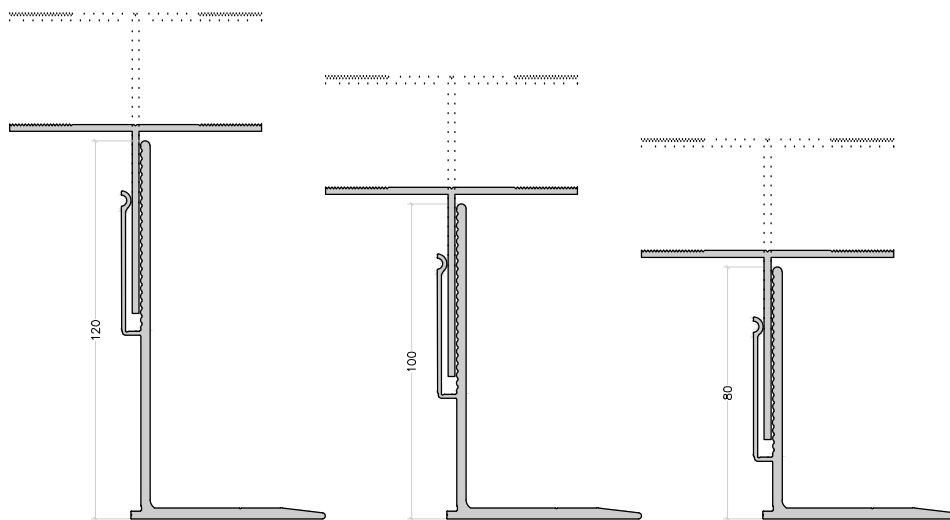

ADJUSTMENT
125 - 165mm

ADJUSTMENT
105 - 145mm

ADJUSTMENT
85 - 125mm

BRACKET	ADJUSTMENT RANGE (mm)
SMART BRACKET 180	185 - 225
SMART BRACKET 160	165 - 205
SMART BRACKET 140	145 - 185
SMART BRACKET 120	125 - 165
SMART BRACKET 100	105 - 145
SMART BRACKET 80	85 - 125

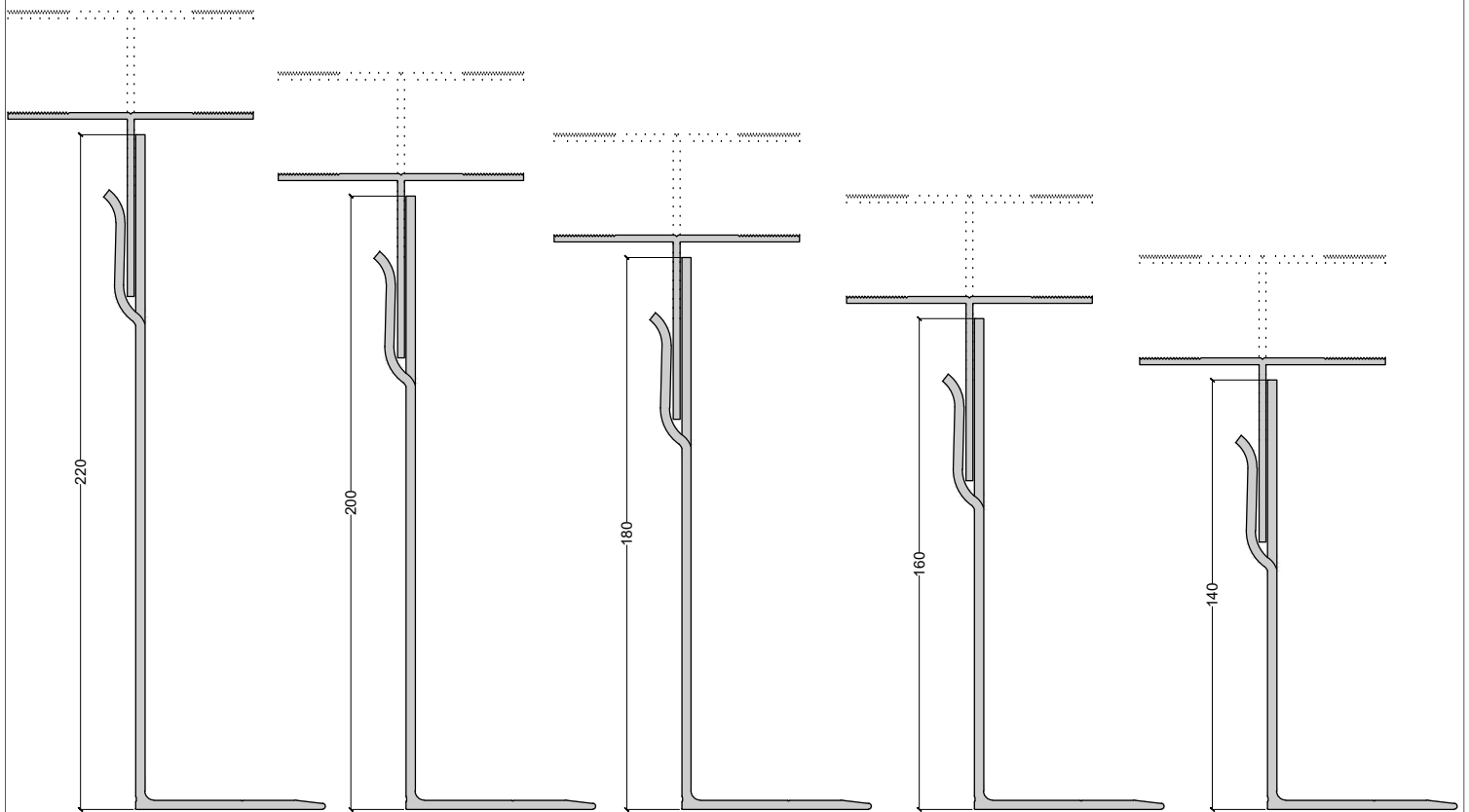

ADJUSTMENT
225 - 265mm

ADJUSTMENT
205 - 245mm

ADJUSTMENT
185 - 225mm

ADJUSTMENT
165 - 205mm

ADJUSTMENT
145 - 175mm

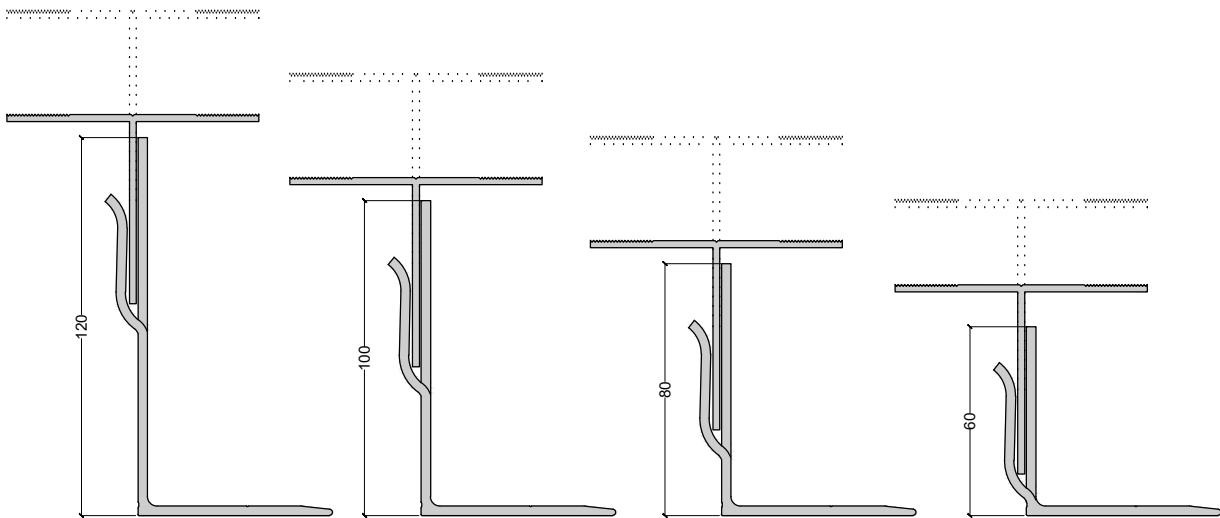

ADJUSTMENT
125 - 165mm

ADJUSTMENT
105 - 145mm

ADJUSTMENT
85 - 125mm

ADJUSTMENT
65 - 105mm

BRACKET	ADJUSTMENT RANGE (mm)
FORTIS BRACKET 220	225 - 265
FORTIS BRACKET 200	205 - 245
FORTIS BRACKET 180	185 - 225
FORTIS BRACKET 160	165 - 205
FORTIS BRACKET 140	145 - 185
FORTIS BRACKET 120	125 - 165
FORTIS BRACKET 100	105 - 145
FORTIS BRACKET 80	85 - 125
FORTIS BRACKET 60	65 - 105

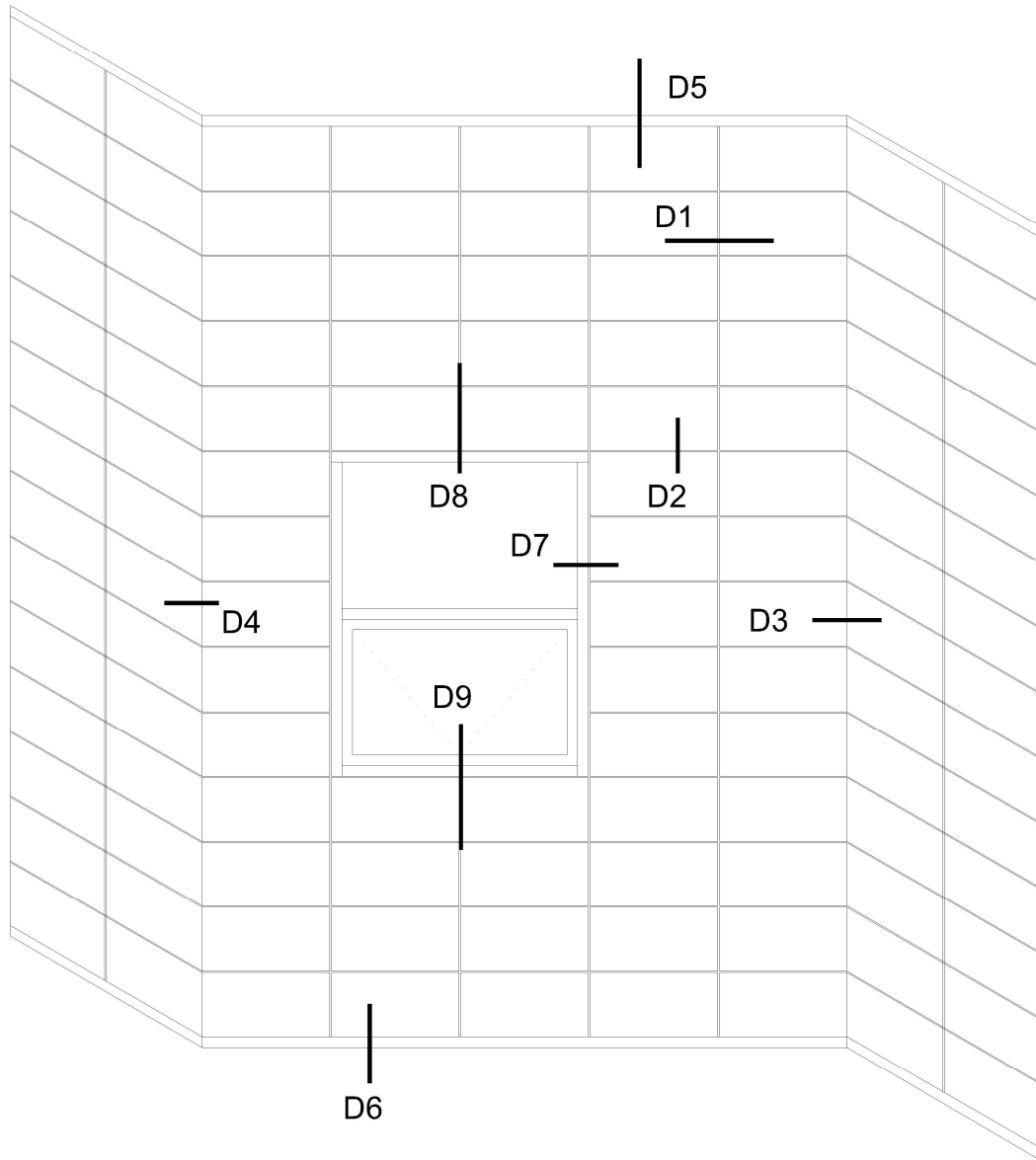

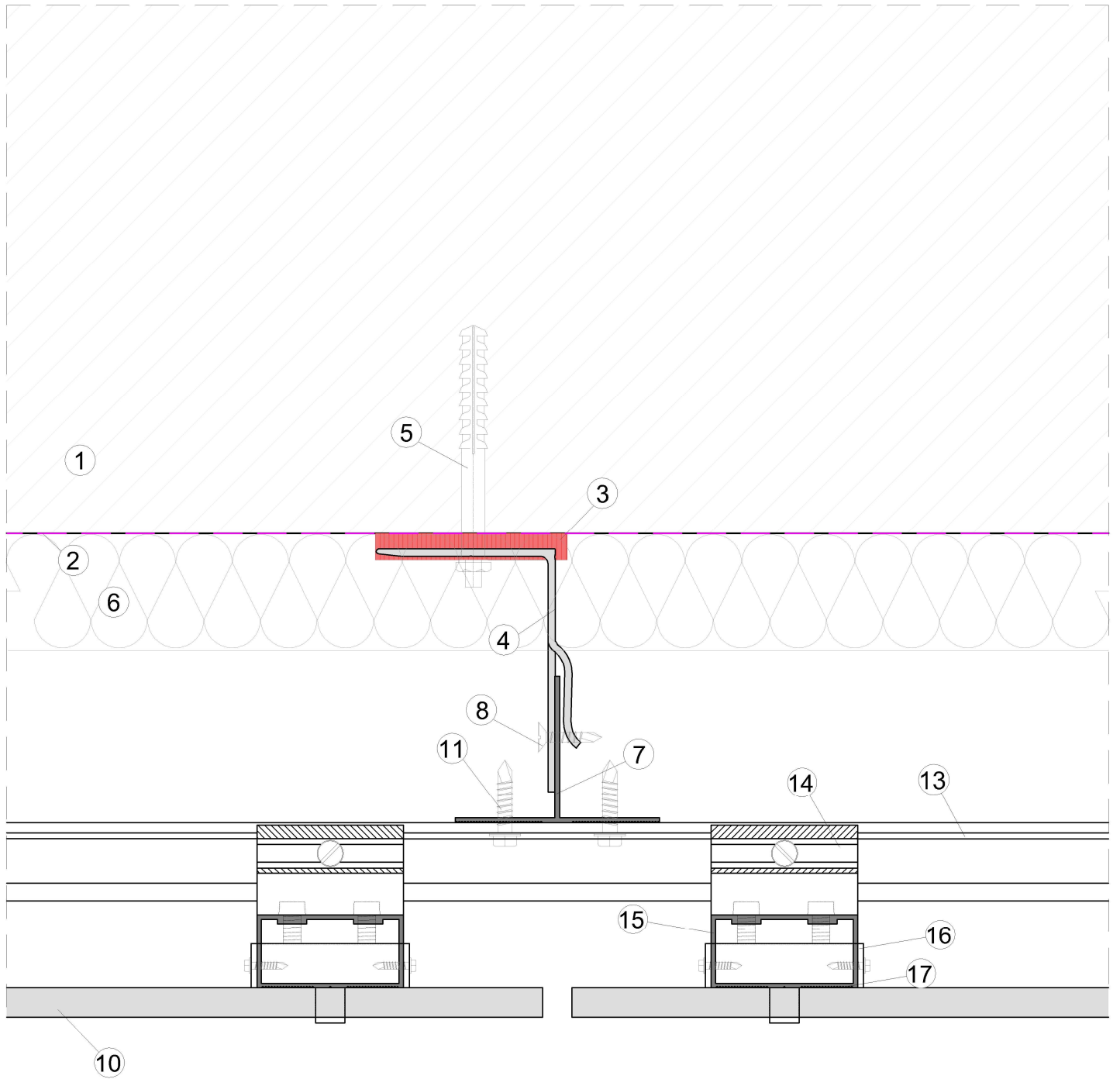

LEGEND

- 1.CONCRETE/BLOCK WORK 2.BREATHER MEMBRANE 3.THERMAL ISOLATOR 4.SUPPORT BRACKET 5.PRIMARY FIXING 6.THERMAL INSULATION 7.T/L/CORNER PROFILE 8.SELF DRILL SCREW
 9.DOUBLE SIDED TAPE/NORTON TAPE 10. GLASS PANEL 11.RIVET/SCREW 12. VENTILATION 13.RAIL PROFILE 14.CLIP 15. BOX SECTION 16. MECHANICAL FIXING BRACKET 17. STRUCTURAL ADHESIVE

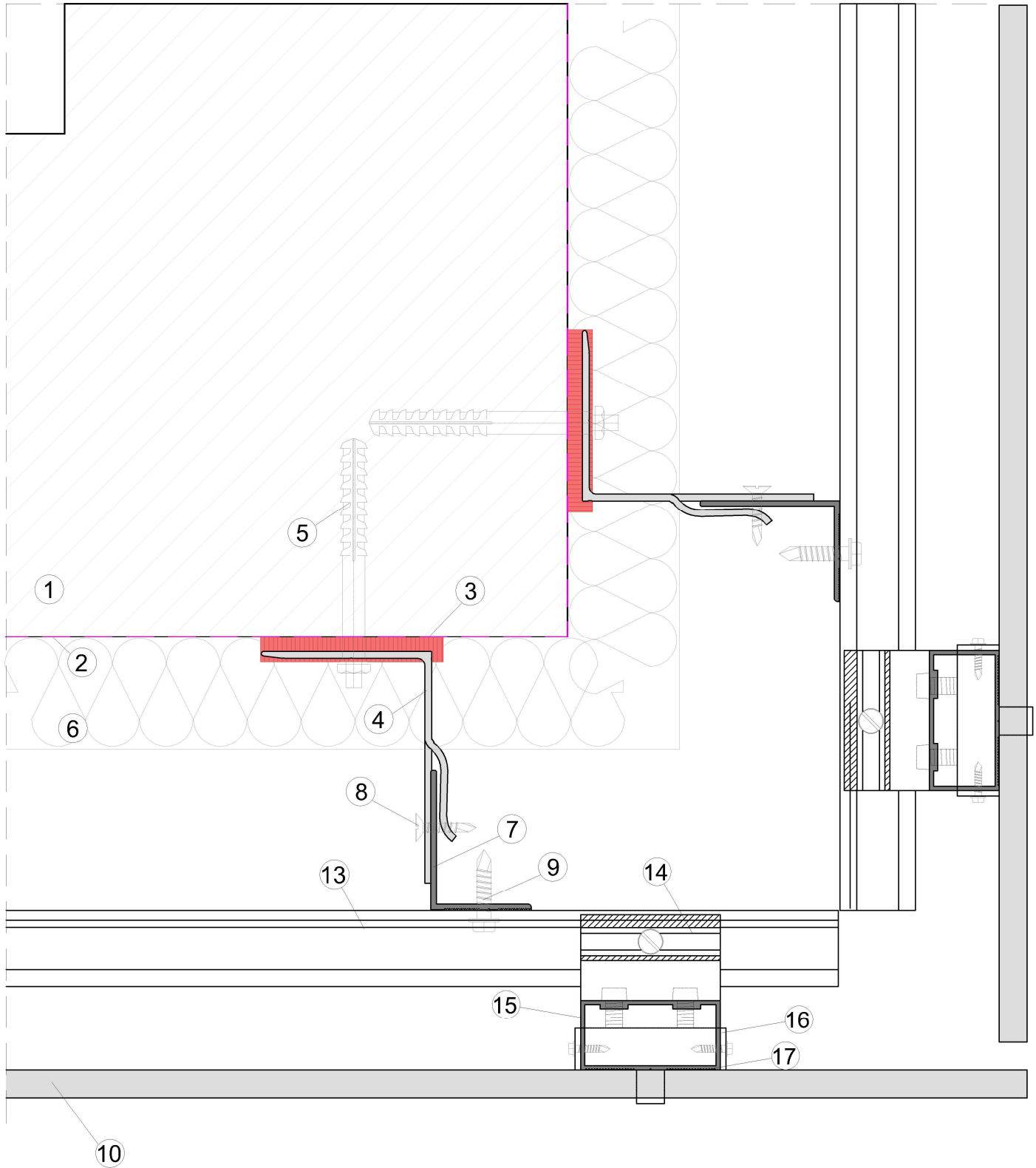

LEGEND

1. CONCRETE/BLOCK WORK 2. BREATHER MEMBRANE 3. THERMAL ISOLATOR 4. SUPPORT BRACKET 5. PRIMARY FIXING 6. THERMAL INSULATION 7. T/L/CORNER PROFILE 8. SELF DRILL SCREW
 9. DOUBLE SIDED TAPE/NORTON TAPE 10. GLASS PANEL 11. RIVET/SCREW 12. VENTILATION 13. RAIL PROFILE 14. CLIP 15. BOX SECTION 16. MECHANICAL FIXING BRACKET 17. STRUCTURAL ADHESIVE



www.cladmate.co.uk | technical@cladmate.co.uk

system title:
**SIKA GLASS CLADDING
 SUPPORT SYSTEM**

drawing title:
DETAIL 2A

date:
Oct 2020

scale:
NTS

system no:
CMS-08 03

drawing no:
03

revision:
P1

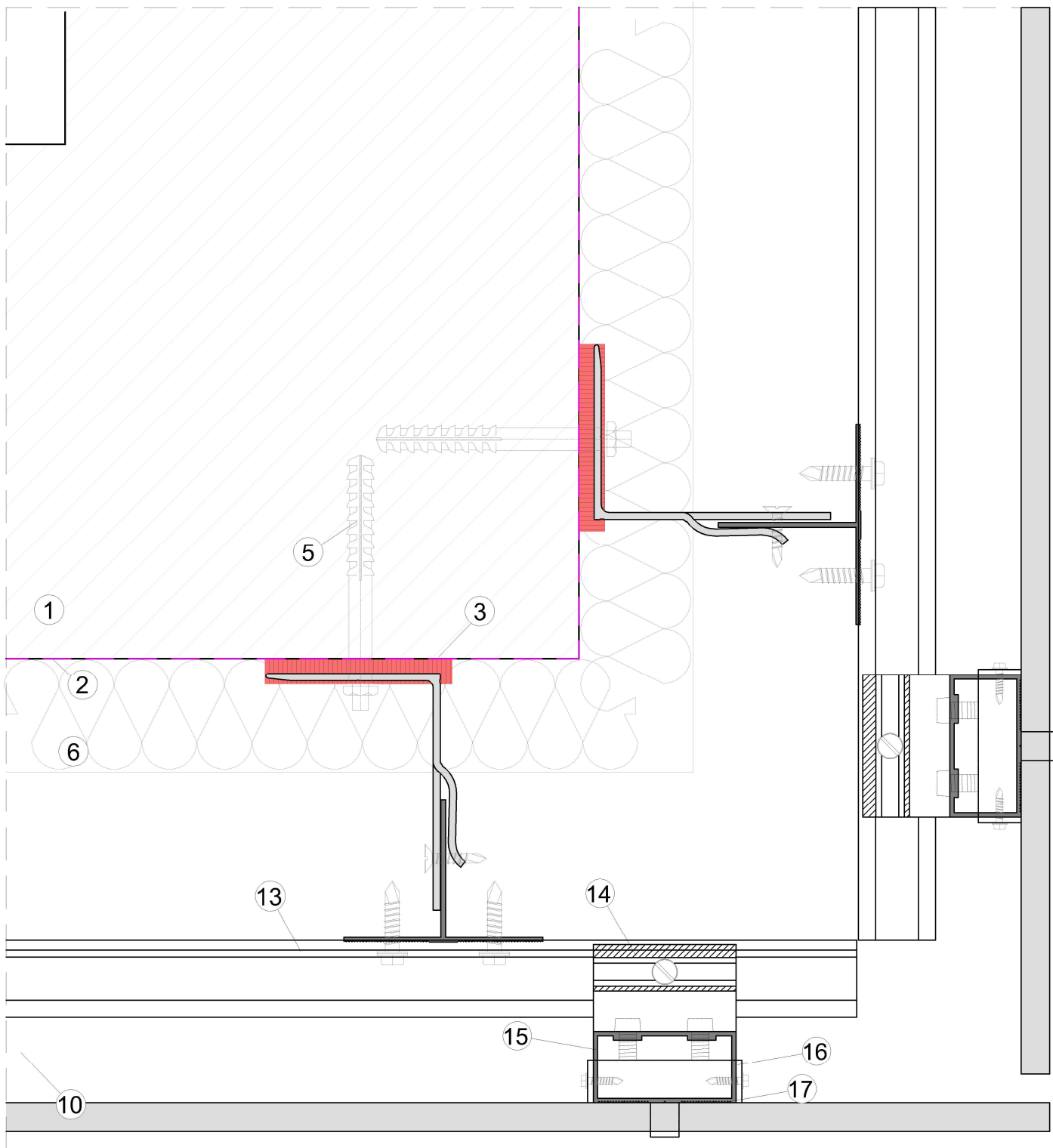

LEGEND

1. CONCRETE/BLOCK WORK 2. BREATHER MEMBRANE 3. THERMAL ISOLATOR 4. SUPPORT BRACKET 5. PRIMARY FIXING 6. THERMAL INSULATION 7. T/L/CORNER PROFILE 8. SELF DRILL SCREW
 9. DOUBLE SIDED TAPE/NORTON TAPE 10. GLASS PANEL 11. RIVET/SCREW 12. VENTILATION 13. RAIL PROFILE 14. CLIP 15. BOX SECTION 16. MECHANICAL FIXING BRACKET 17. STRUCTURAL ADHESIVE



www.cladmate.co.uk | technical@cladmate.co.uk

system title:
**SIKA GLASS CLADDING
 SUPPORT SYSTEM**

drawing title:
DETAIL 2B

date:
Oct 2020

scale:
NTS

system no:
CMS-08 04

drawing no:
04

revision:
P1

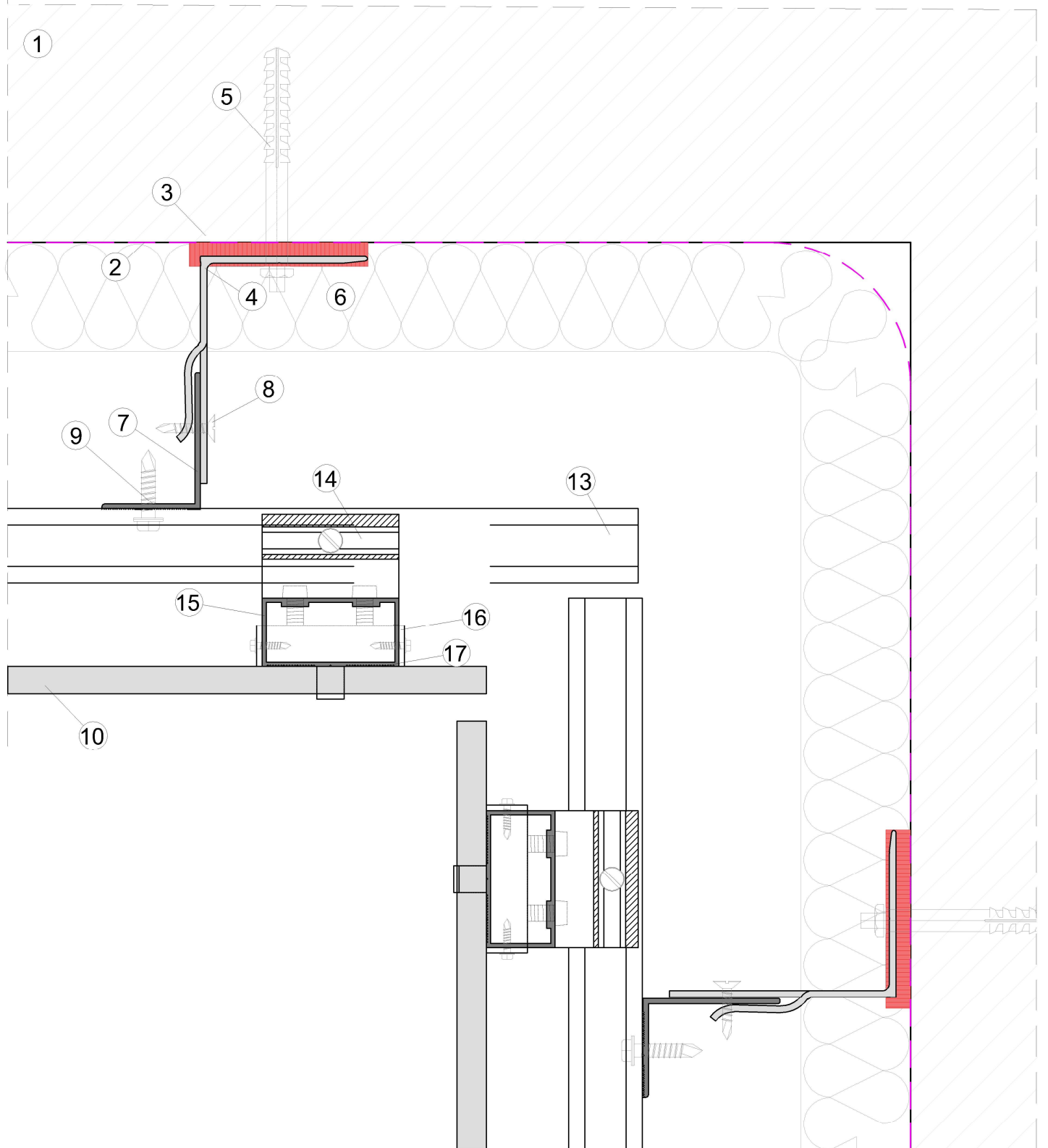

LEGEND
 1. CONCRETE/BLOCK WORK 2. BREATHER MEMBRANE 3. THERMAL ISOLATOR 4. SUPPORT BRACKET 5. PRIMARY FIXING 6. THERMAL INSULATION 7. T/L CORNER PROFILE 8. SELF DRILL SCREW
 9. DOUBLE SIDED TAPE/NORTON TAPE 10. GLASS PANEL 11. RIVET/SCREW 12. VENTILATION 13. RAIL PROFILE 14. CLIP 15. BOX SECTION 16. MECHANICAL FIXING BRACKET 17. STRUCTURAL ADHESIVE



system title:
**SIKA GLASS CLADDING
 SUPPORT SYSTEM**

drawing title:
DETAIL 3

date: Oct 2020 scale: NTS

system no: CMS-08 drawing no: 05 revision: P1

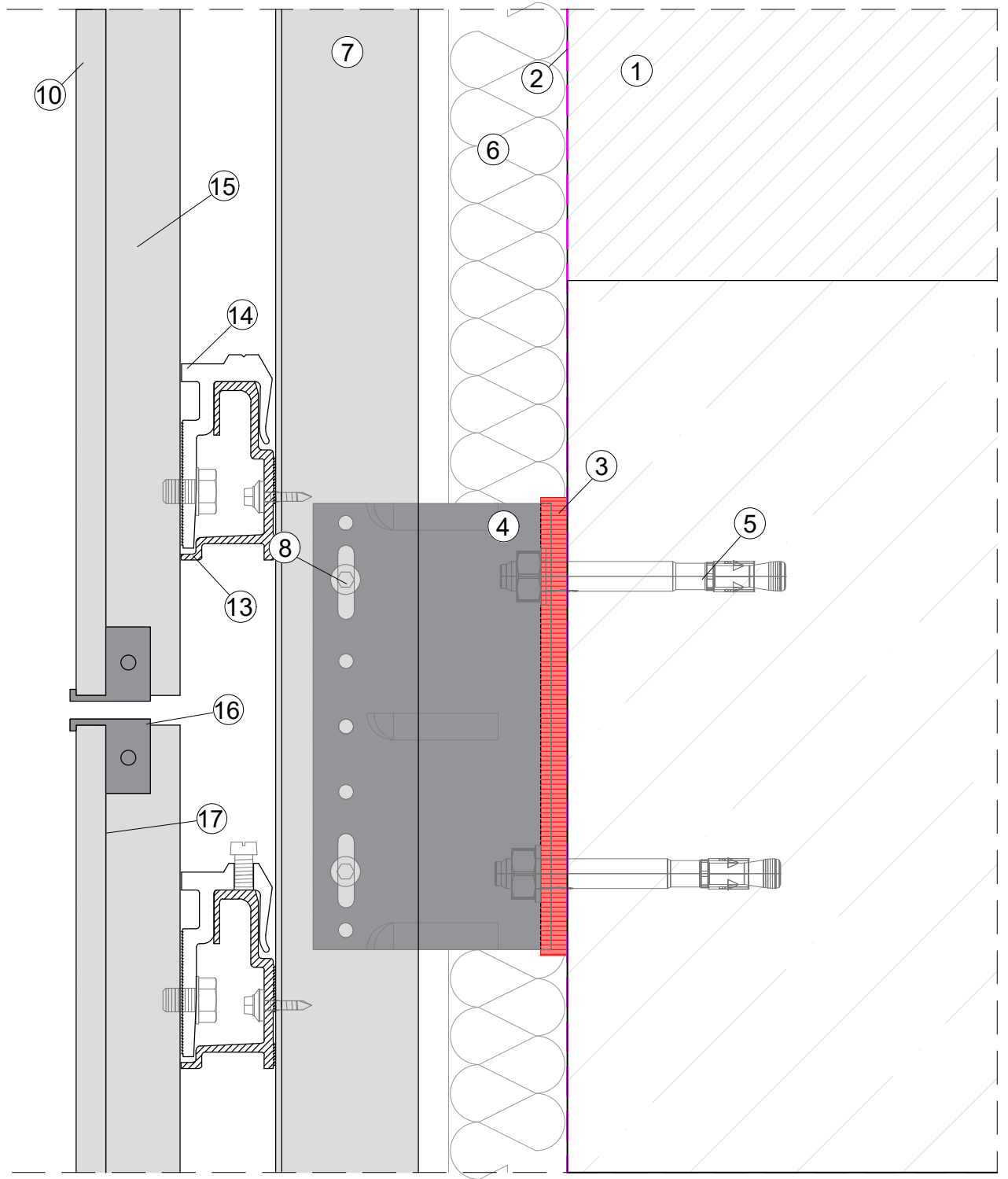

LEGEND

1. CONCRETE/BLOCK WORK 2. BREATHER MEMBRANE 3. THERMAL ISOLATOR 4. SUPPORT BRACKET 5. PRIMARY FIXING 6. THERMAL INSULATION 7. T/L/CORNER PROFILE 8. SELF DRILL SCREW
 9. DOUBLE SIDED TAPE/NORTON TAPE 10. GLASS PANEL 11. RIVET/SCREW 12. VENTILATION 13. RAIL PROFILE 14. CLIP 15. BOX SECTION 16. MECHANICAL FIXING BRACKET 17. STRUCTURAL ADHESIVE



www.cladmate.co.uk | technical@cladmate.co.uk

system title:
**SIKA GLASS CLADDING
 SUPPORT SYSTEM**

drawing title:
DETAIL 4

date:
Oct 2020

scale:
NTS

system no:
CMS-08 06

drawing no:
06

revision:
P1

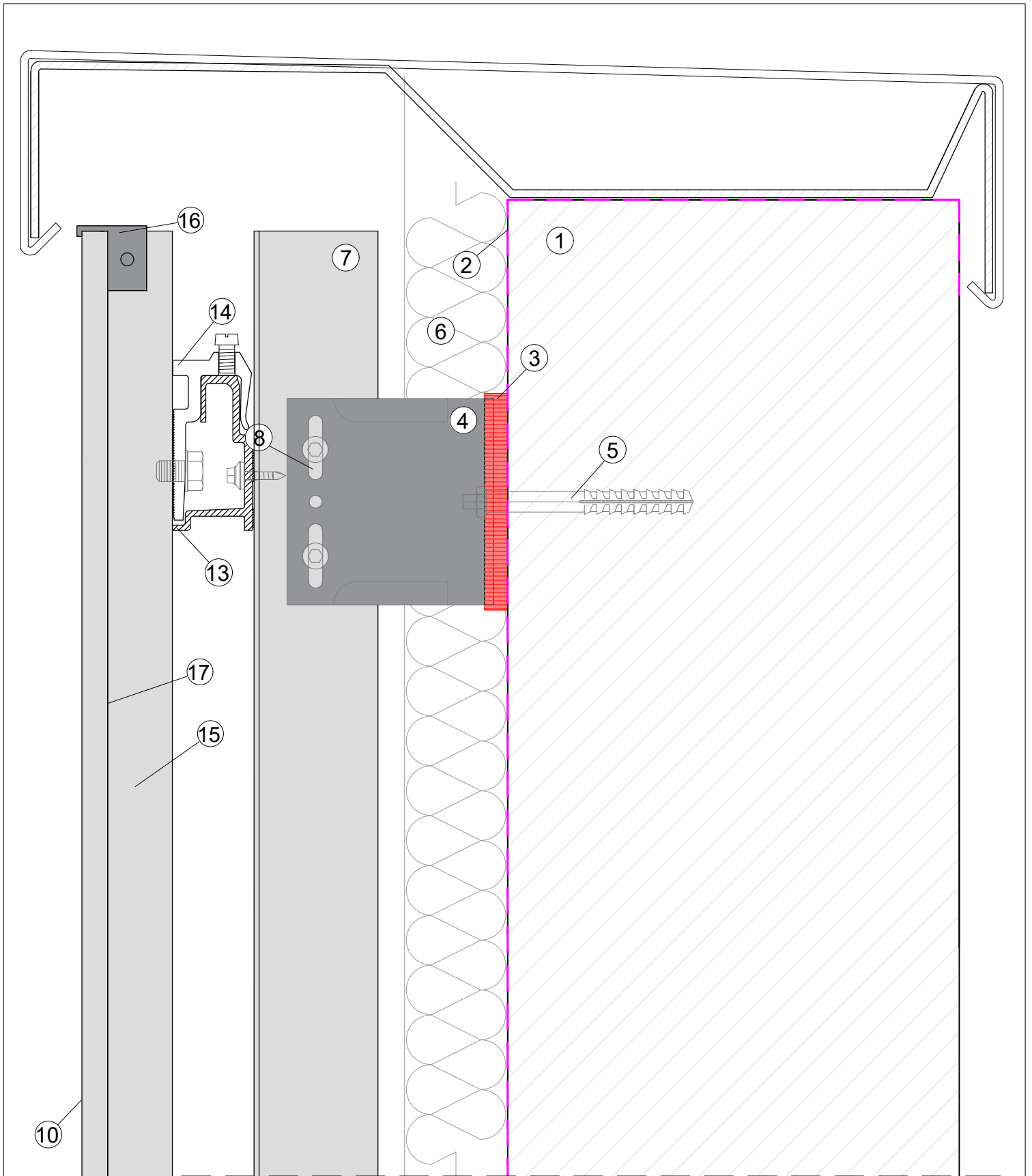

LEGEND
 1. CONCRETE/BLOCK WORK 2. BREATHER MEMBRANE 3. THERMAL ISOLATOR 4. SUPPORT BRACKET 5. PRIMARY FIXING 6. THERMAL INSULATION 7. T/L/CORNER PROFILE 8. SELF DRILL SCREW
 9. DOUBLE SIDED TAPE/NORTON TAPE 10. GLASS PANEL 11. RIVET/SCREW 12. VENTILATION 13. RAIL PROFILE 14. CLIP 15. BOX SECTION 16. MECHANICAL FIXING BRACKET 17. STRUCTURAL ADHESIVE



system title:
**SIKA GLASS CLADDING
 SUPPORT SYSTEM**

drawing title:
DETAIL 5

date:
Oct 2020

scale:
NTS

system no: **CMS-08** drawing no: **07** revision: **P1**

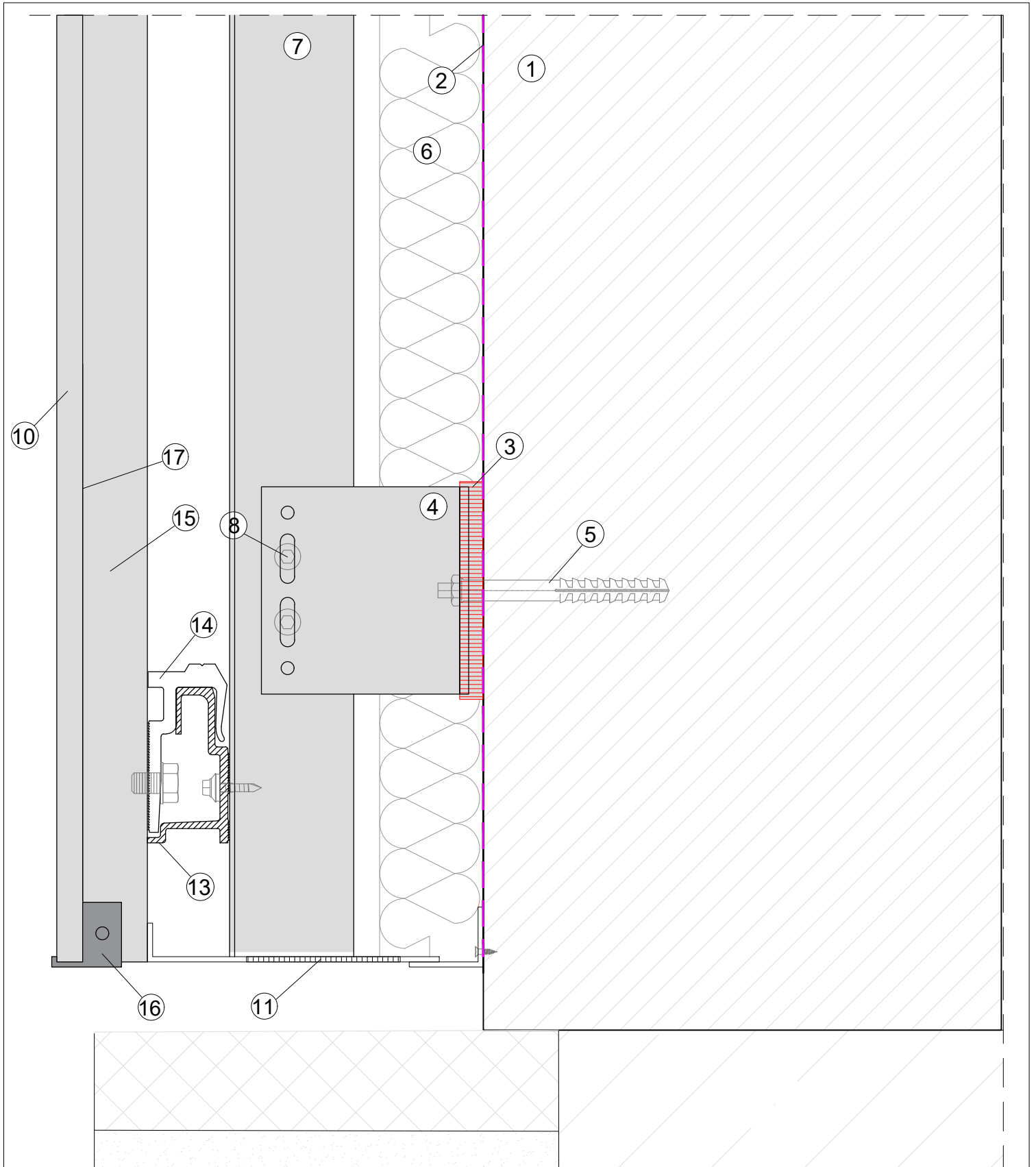

LEGEND
 1. CONCRETE/BLOCK WORK 2. BREATHER MEMBRANE 3. THERMAL ISOLATOR 4. SUPPORT BRACKET 5. PRIMARY FIXING 6. THERMAL INSULATION 7. T/L/CORNER PROFILE 8. SELF DRILL SCREW
 9. DOUBLE SIDED TAPE/NORTON TAPE 10. GLASS PANEL 11. RIVET/SCREW 12. VENTILATION 13. RAIL PROFILE 14. CLIP 15. BOX SECTION 16. MECHANICAL FIXING BRACKET 17. STRUCTURAL ADHESIVE



system title:
**SIKA GLASS CLADDING
 SUPPORT SYSTEM**

drawing title:
DETAIL 6

date: Oct 2020 scale: NTS

system no: CMS-08 drawing no: 08 revision: P1

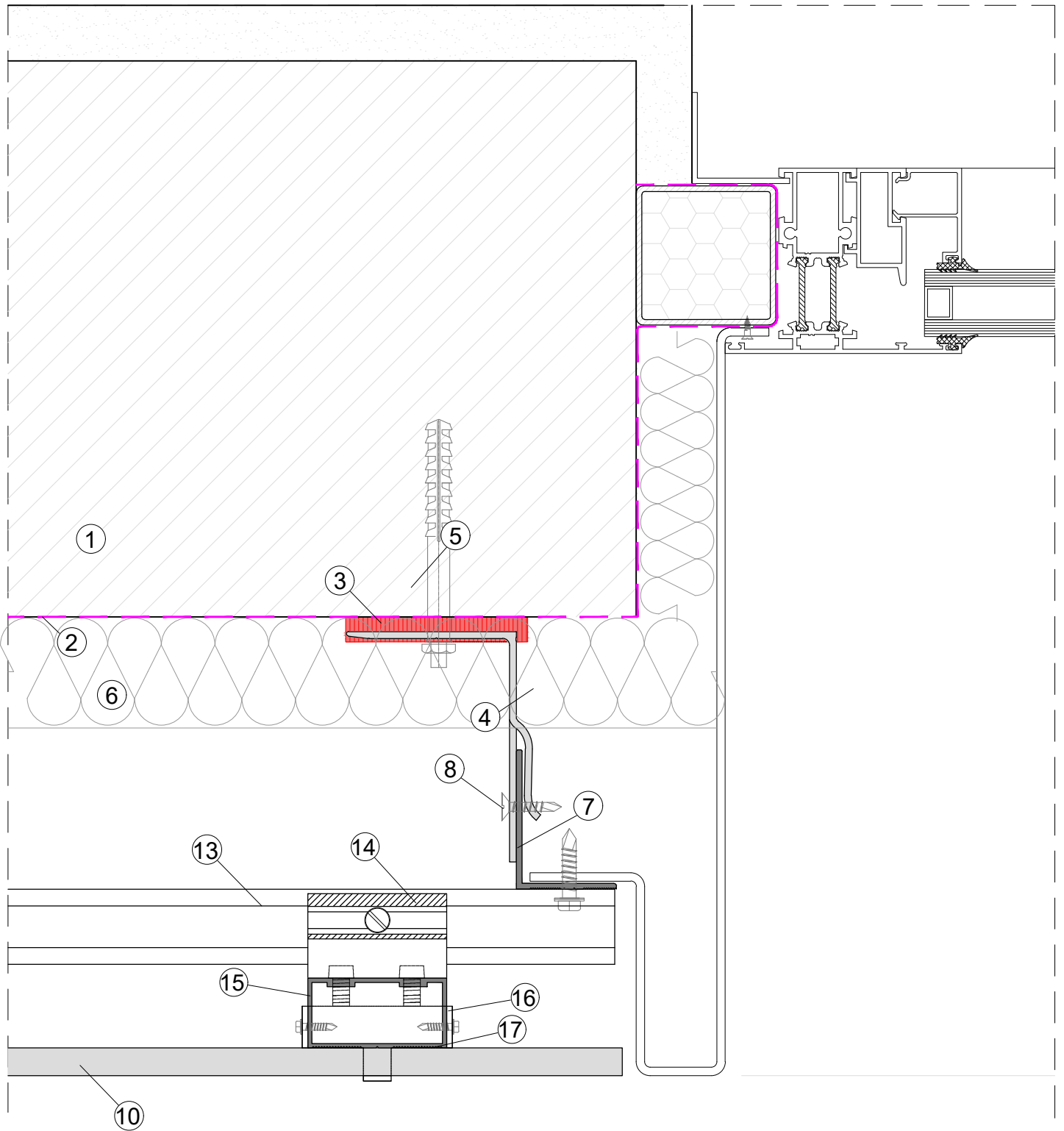

LEGEND
 1. CONCRETE/BLOCK WORK 2. BREATHER MEMBRANE 3. THERMAL ISOLATOR 4. SUPPORT BRACKET 5. PRIMARY FIXING 6. THERMAL INSULATION 7. T/L/CORNER PROFILE 8. SELF DRILL SCREW
 9. DOUBLE SIDED TAPE/NORTON TAPE 10. GLASS PANEL 11. RIVET/SCREW 12. VENTILATION 13. RAIL PROFILE 14. CLIP 15. BOX SECTION 16. MECHANICAL FIXING BRACKET 17. STRUCTURAL ADHESIVE



system title:
**SIKA GLASS CLADDING
 SUPPORT SYSTEM**

drawing title:
DETAIL 7

date:
Oct 2020 scale:
NTS

system no.: **CMS-08** drawing no.: **09** revision:
P1

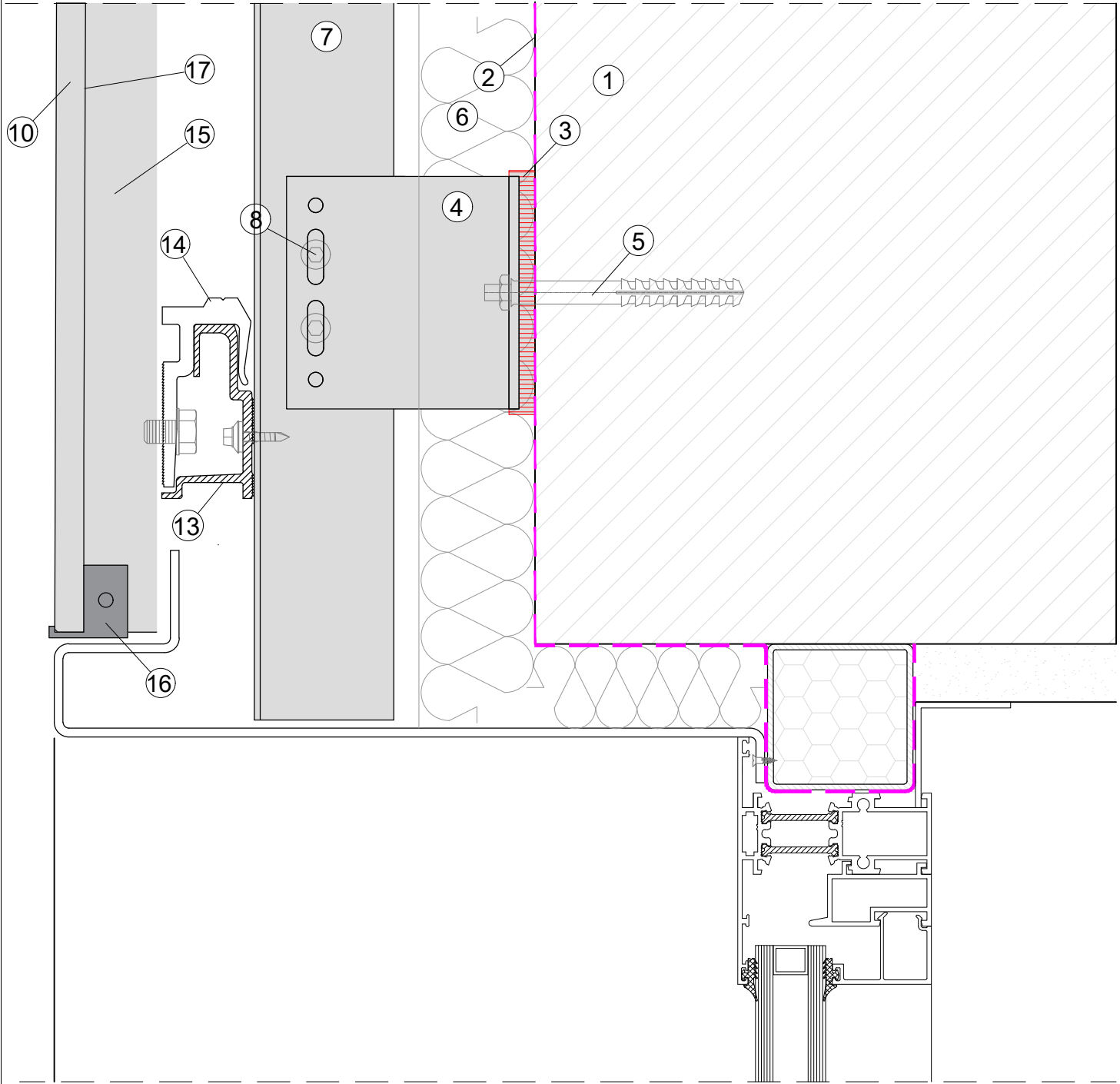

LEGEND

1. CONCRETE/BLOCK WORK 2. BREATHER MEMBRANE 3. THERMAL ISOLATOR 4. SUPPORT BRACKET 5. PRIMARY FIXING 6. THERMAL INSULATION 7. T/L/CORNER PROFILE 8. SELF DRILL SCREW
 9. DOUBLE SIDED TAPE/NORTON TAPE 10. GLASS PANEL 11. RIVET/SCREW 12. VENTILATION 13. RAIL PROFILE 14. CLIP 15. BOX SECTION 16. MECHANICAL FIXING BRACKET 17. STRUCTURAL ADHESIVE



www.cladmate.co.uk | technical@cladmate.co.uk

system title:
**SIKA GLASS CLADDING
 SUPPORT SYSTEM**

drawing title:
DETAIL 8

date:
Oct 2020 scale:
NTS

system no: **CMS-08** drawing no: **10** revision:
P1

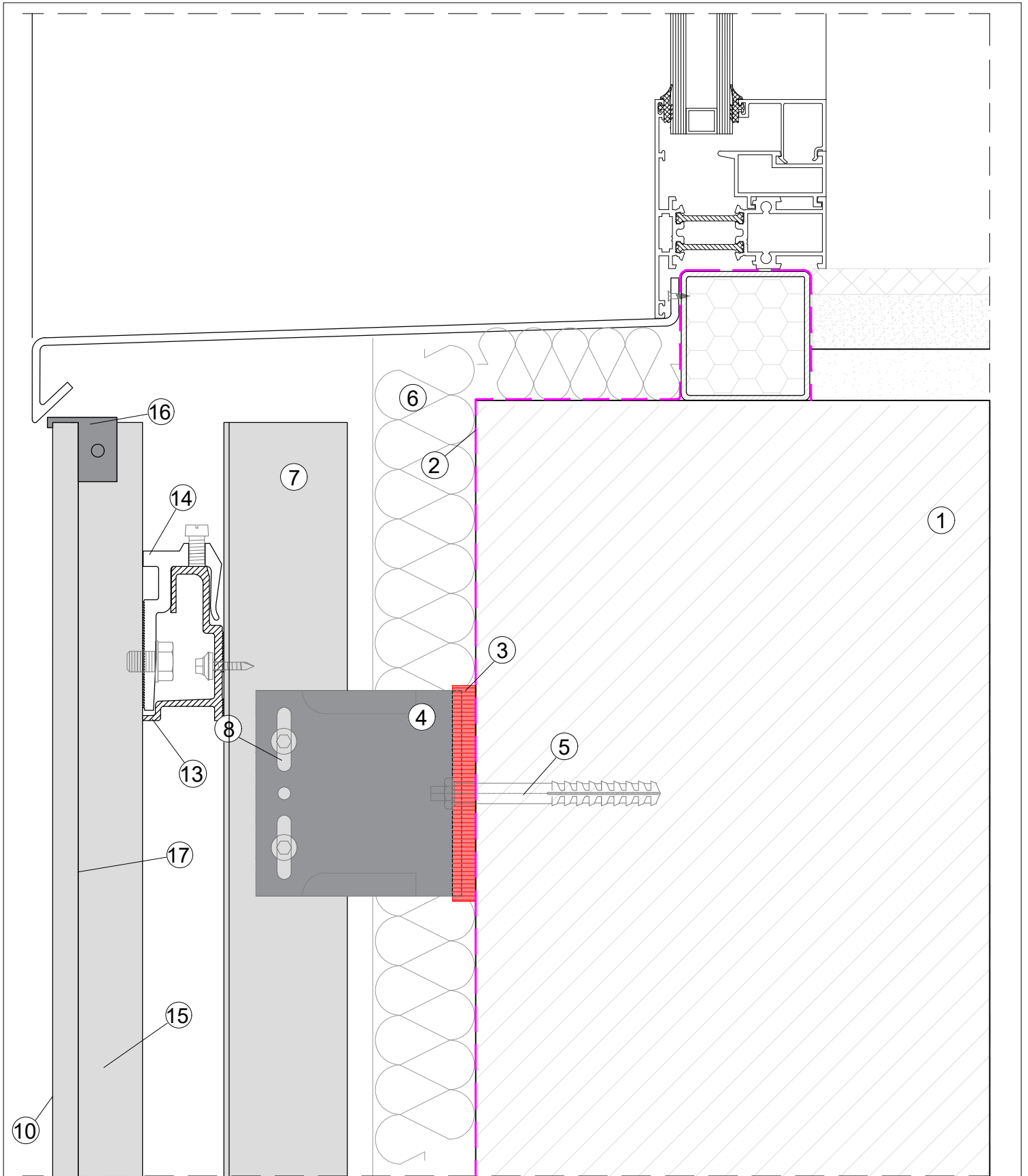

LEGEND
 1. CONCRETE/BLOCK WORK 2. BREATHER MEMBRANE 3. THERMAL INSULATOR 4. SUPPORT BRACKET 5. PRIMARY FIXING 6. THERMAL INSULATION 7. T/L/CORNER PROFILE 8. SELF DRILL SCREW
 9. DOUBLE SIDED TAPE/NORTON TAPE 10. GLASS PANEL 11. RIVET/SCREW 12. VENTILATION 13. RAIL PROFILE 14. CLIP 15. BOX SECTION 16. MECHANICAL FIXING BRACKET 17. STRUCTURAL ADHESIVE



system title:
**SIKA GLASS CLADDING
 SUPPORT SYSTEM**

drawing title:
DETAIL 9

date: Oct 2020 scale: NTS

system no: CMS-08 drawing no: 11 revision: P1

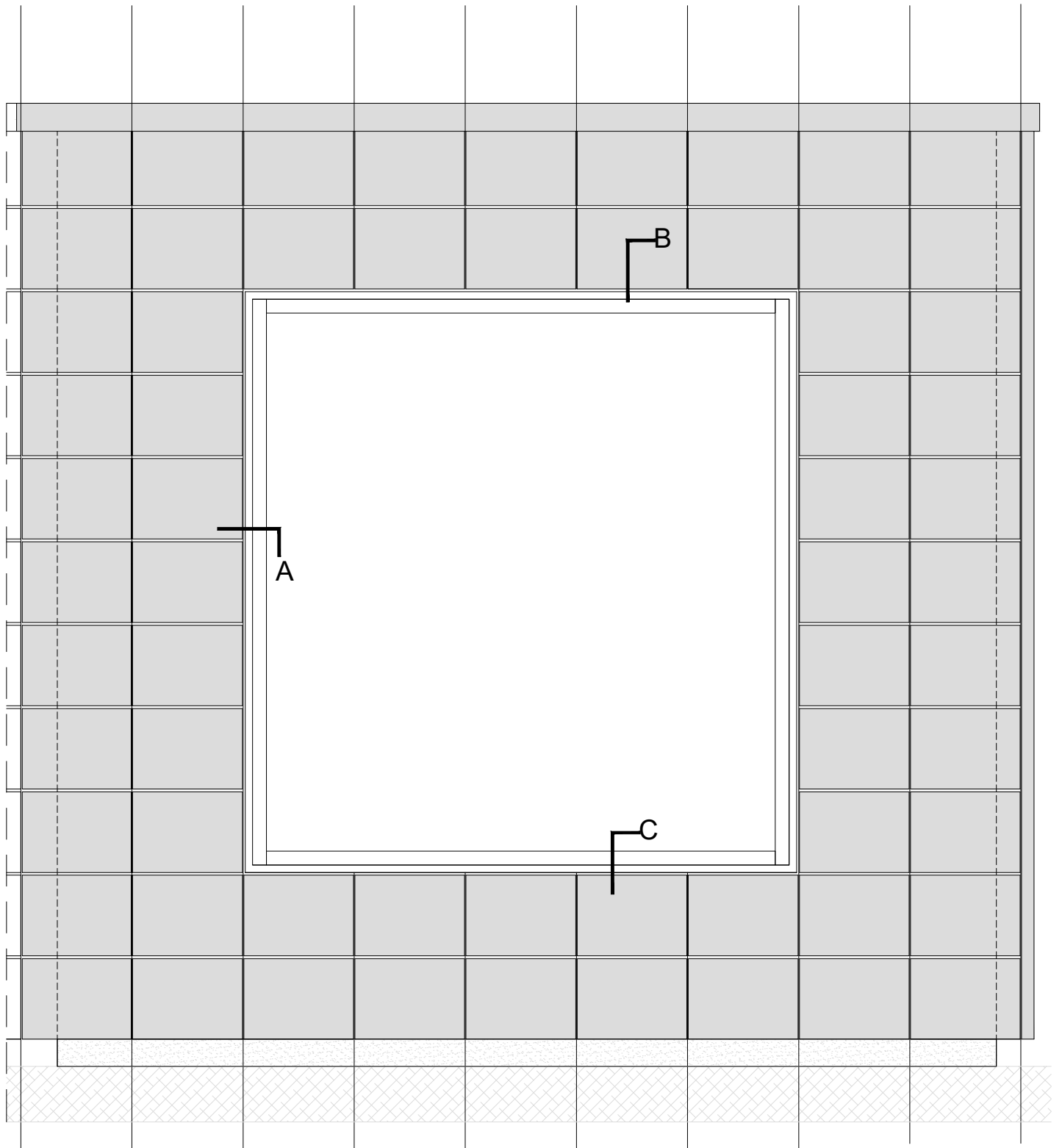

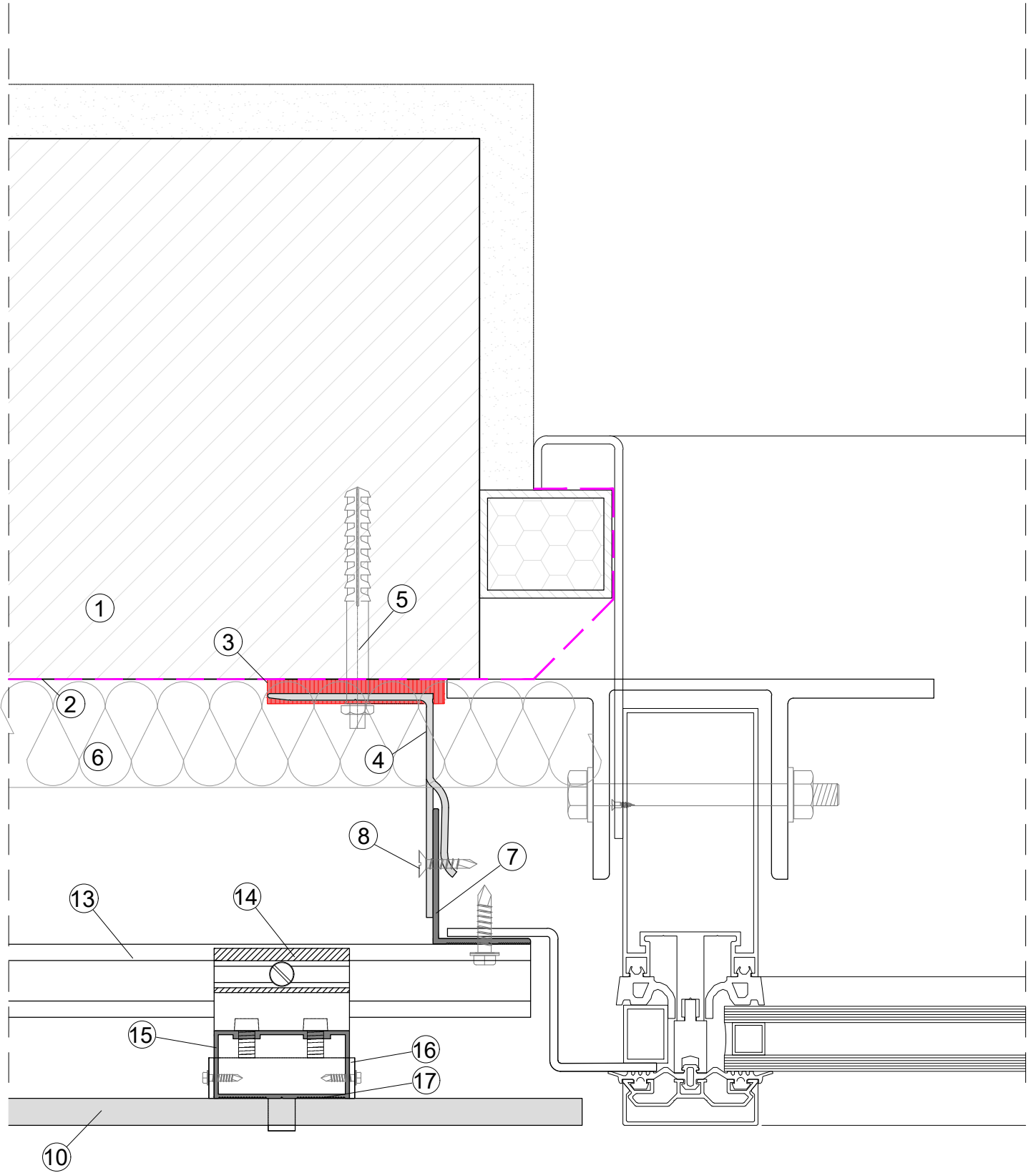

LEGEND

1. CONCRETE/BLOCK WORK 2. BREATHER MEMBRANE 3. THERMAL ISOLATOR 4. SUPPORT BRACKET 5. PRIMARY FIXING 6. THERMAL INSULATION 7. T/L/CORNER PROFILE 8. SELF DRILL SCREW
 9. DOUBLE SIDED TAPE/NORTON TAPE 10. GLASS PANEL 11. RIVET/SCREW 12. VENTILATION 13. RAIL PROFILE 14. CLIP 15. BOX SECTION 16. MECHANICAL FIXING BRACKET 17. STRUCTURAL ADHESIVE



system title:
**SIKA GLASS CLADDING
 SUPPORT SYSTEM**

drawing title:
DETAIL A

date:
Oct 2020

scale:
NTS

system no:
CMS-08 13

drawing no:
13

revision:
P1

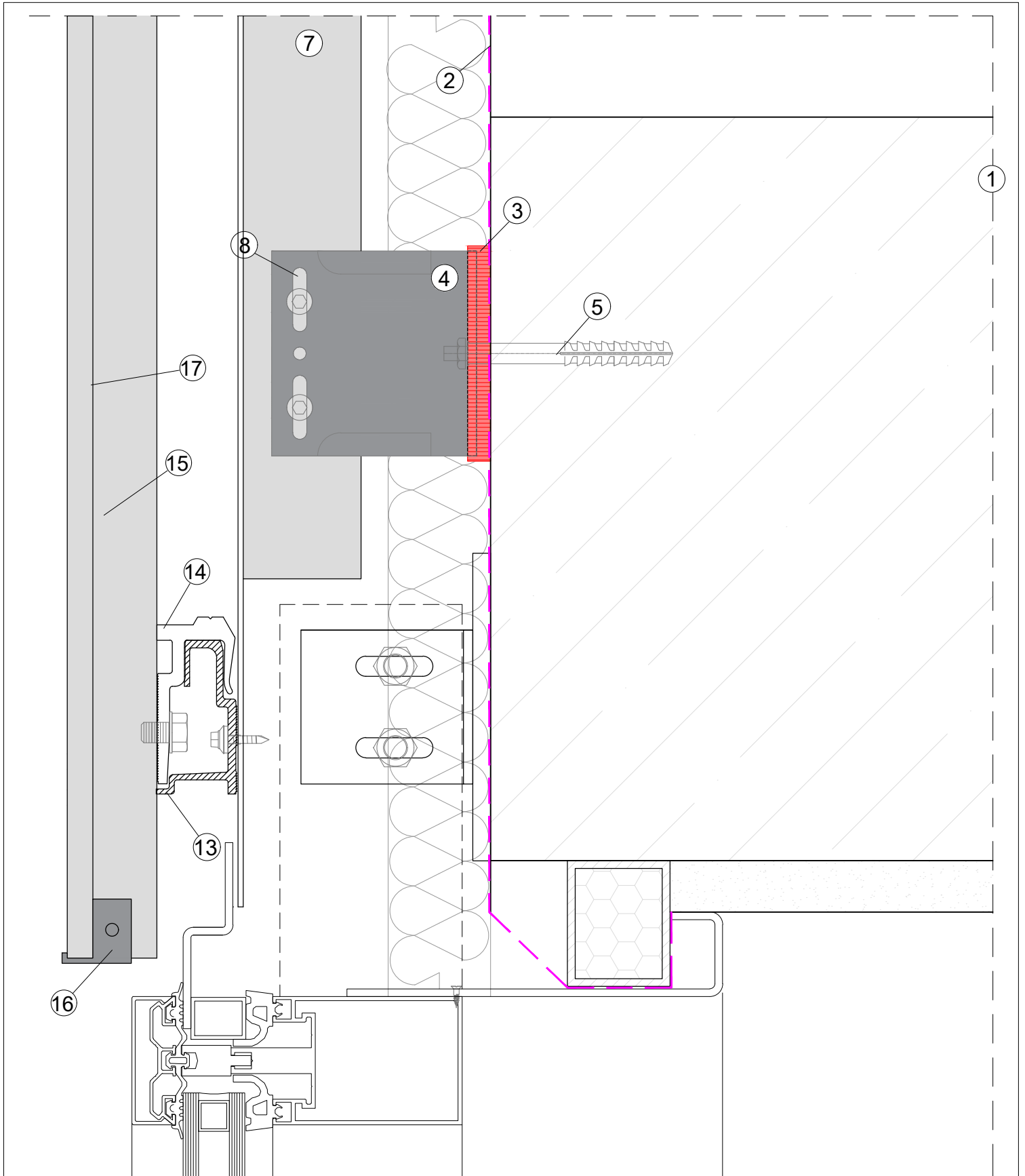

LEGEND
 1. CONCRETE/BLOCK WORK 2. BREATHER MEMBRANE 3. THERMAL ISOLATOR 4. SUPPORT BRACKET 5. PRIMARY FIXING 6. THERMAL INSULATION 7. T/L/CORNER PROFILE 8. SELF DRILL SCREW
 9. DOUBLE SIDED TAPE/NORTON TAPE 10. GLASS PANEL 11. RIVET/SCREW 12. VENTILATION 13. RAIL PROFILE 14. CLIP 15. BOX SECTION 16. MECHANICAL FIXING BRACKET 17. STRUCTURAL ADHESIVE



system title:
**SIKA GLASS CLADDING
 SUPPORT SYSTEM**

drawing title:
DETAIL B

date:
Oct 2020

scale:
NTS

system no: **CMS-08** drawing no: **14** revision: **P1**

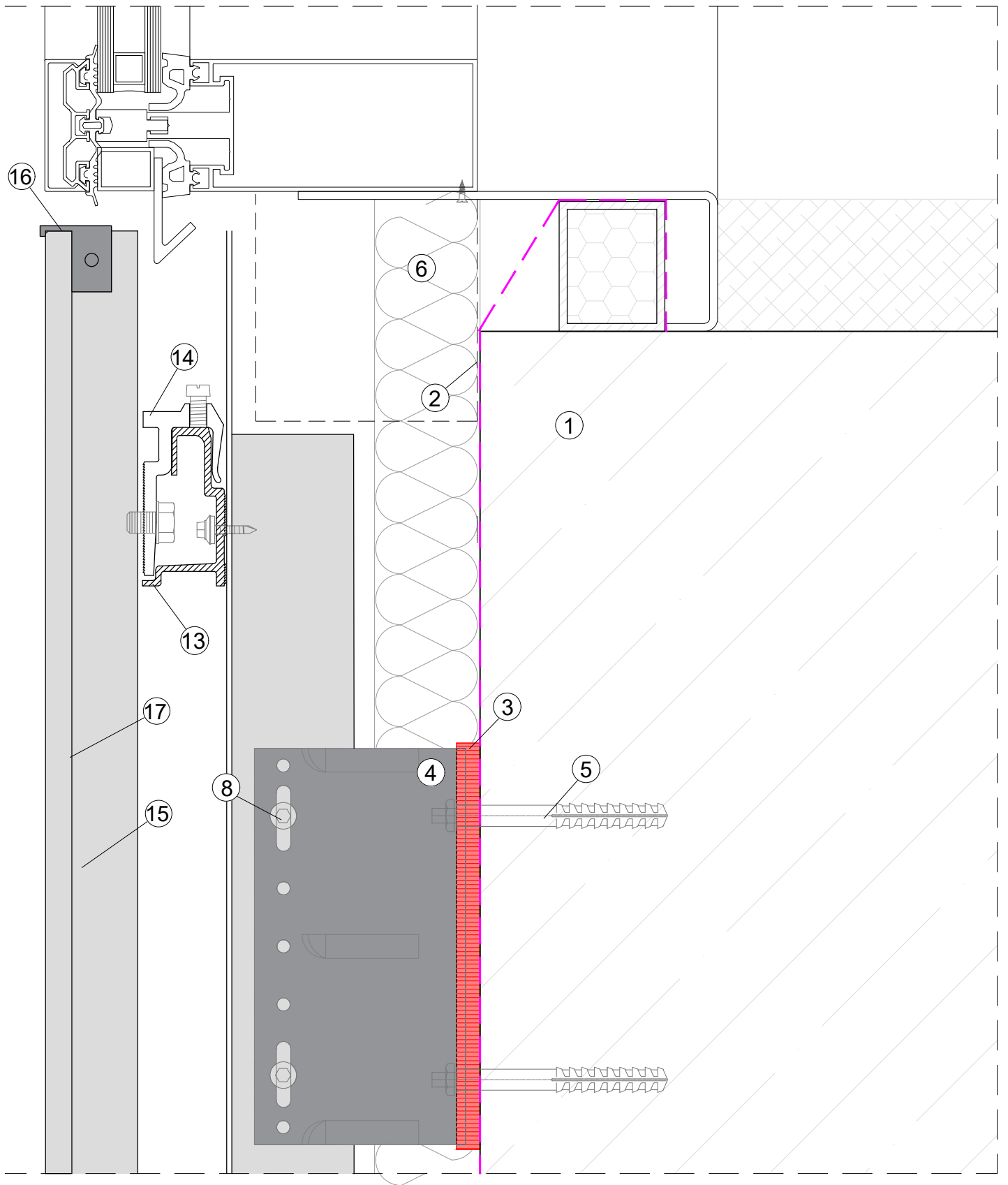

LEGEND
 1. CONCRETE/BLOCK WORK 2. BREATHER MEMBRANE 3. THERMAL INSULATOR 4. SUPPORT BRACKET 5. PRIMARY FIXING 6. THERMAL INSULATION 7. T/L CORNER PROFILE 8. SELF DRILL SCREW
 9. DOUBLE SIDED TAPE/NORTON TAPE 10. GLASS PANEL 11. RIVET/SCREW 12. VENTILATION 13. RAIL PROFILE 14. CLIP 15. BOX SECTION 16. MECHANICAL FIXING BRACKET 17. STRUCTURAL ADHESIVE



system title:
**SIKA GLASS CLADDING
 SUPPORT SYSTEM**

drawing title:
DETAIL C

date: Oct 2020 scale: NTS

system no: CMS-08 drawing no: 15 revision: P1